

INDUSTRIAL LINE



**TECNOOPERFIL®**

**INDUSTRIAL CATALOG**

# High-Performance Thermoplastic Solutions

About the

# COMPANY

Since 1994, Tecoperfil has stood out for offering innovative thermoplastic products, with a focus on PVC. With three decades of experience, the company creates customized solutions for construction, industry, services, and hydroponic agriculture.

The ISO 9001 certification attests to Tecoperfil ommitment to quality. This dedication not only strengthens customer confidence but also opens up new business perspectives.



Conscious of its role in the industry, society, and the environment, TECNOPERFIL strives to implement activities that seek the development of its employees, through participatory management that promotes social responsibility.



More information at  
[www.tecoperfil.com.br/tecno/](http://www.tecoperfil.com.br/tecno/)



## High-Performance Thermoplastic Solutions

### About the PRODUCTS

Among Tecnoperfil's main products are profiles for refrigeration, label holders, rails for electronic tags, wall protective profiles for checkouts, Vinylshock handrails and door stops, corner guards, finishing profiles for ceramic coatings, and Hortivinyl hydroponic products.

The company also develops customized technical profiles according to customer needs, elaborating projects for profiles for various purposes.

## ISO 9001

Tecnoperfil has obtained ISO 9001 certification, which means that it follows the criteria and requirements established to guarantee the quality of its products and services.

This demonstrates the company's commitment to meeting customer needs and continuously improving its processes.

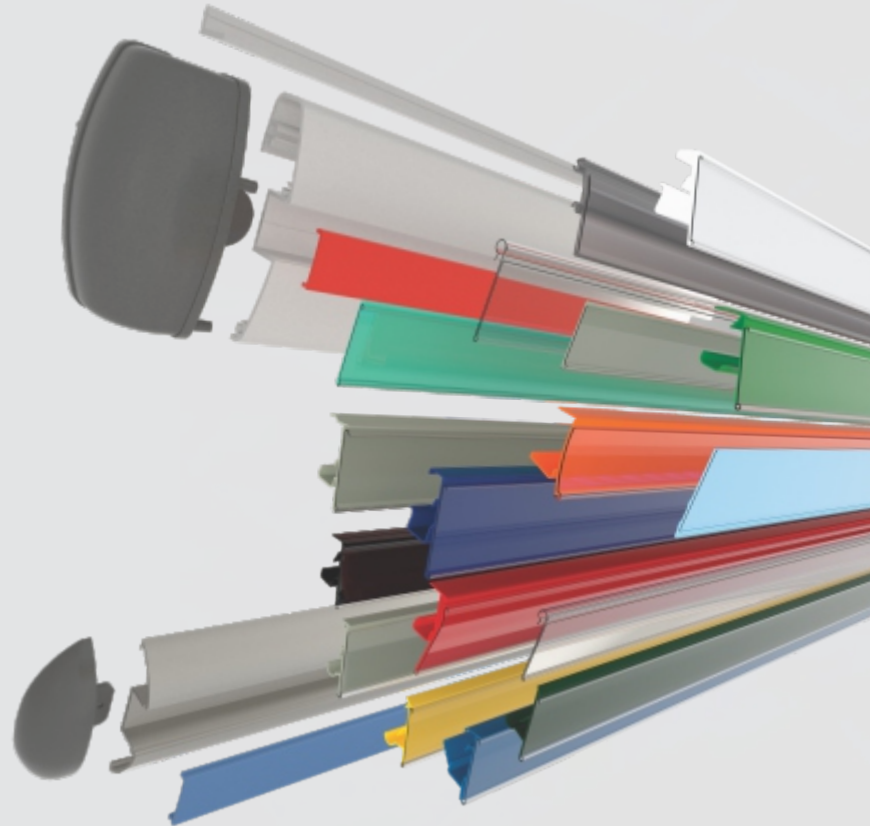

# < CANTONEIRAS >

## CORNER GUARDS

Tecnofil's Edge Protectors are sturdy and durable profiles designed to protect corners against impacts. They make environments more hygienic by facilitating cleaning.

They can be used for finishing in various applications, such as in internal linings of freight trucks, clean rooms, cold storage rooms, and in the general industry.



# CORNER GUARDS

## Equal Flap Overlapping Corner Guards

**TEC 009**

50 mm x 50 mm

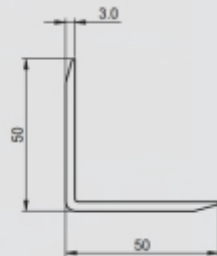
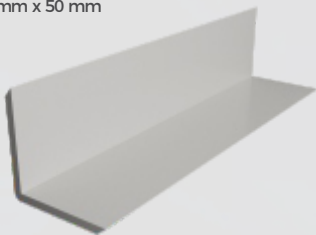

**COLORS**

103	778	467	409
411	303	637	288

## Equal Flap Overlapping Corner Guards

**TEC 029**

40 mm x 40 mm

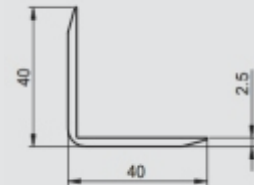
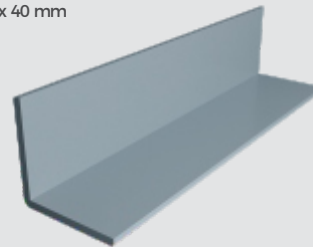

**COLORS**

103	778	467	409
411	303	637	288

## Equal Flap Overlapping Corner Guards

**TEC 242**

25 mm x 25 mm

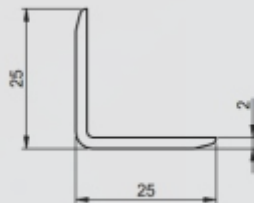
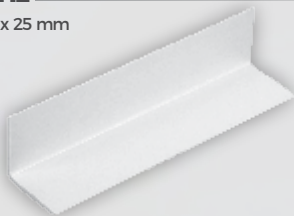

**COLORS**

103	778	467	409
411	303	637	288

## Equal Flap Overlapping Corner Guards

**TEC 216**

50 mm x 50 mm

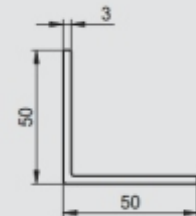

**COLORS**

162

Otros colores, consultar.

# CORNER GUARDS

## Equal Flap Overlapping Corner Guards

### TEC 229

50 mm x 50 mm

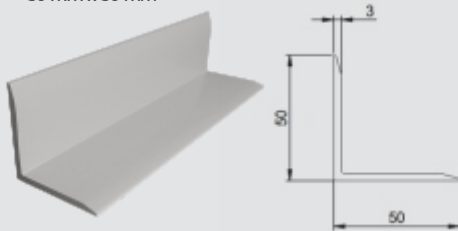

#### COLORS

162 651

Demais cores, sob consulta.

## Equal Flap Overlapping Corner Guards

### TEC 241

19 mm x 19 mm

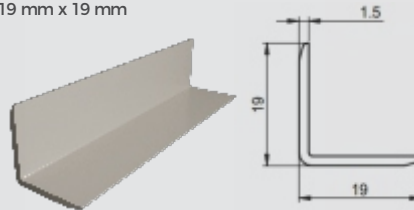

#### COLORS

103 778 467  
409 411 303  
637 288

## Equal Flap Overlapping Corner Guards

### TEC 258

37 mm x 37 mm

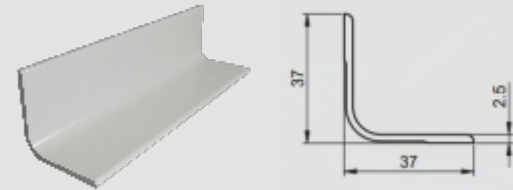

#### COLORS

108

Other colors, please inquire.

## Overlapping Inner Corner

### TEC 188

48,1 mm x 48,1 mm

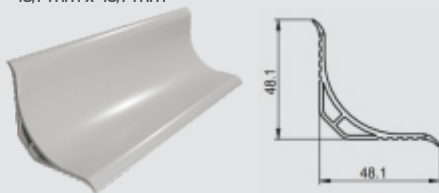

#### COLORS

184 374 651

## Overlapping Inner Corner

### TEC 259 | TEC 260

25 mm x 62 mm

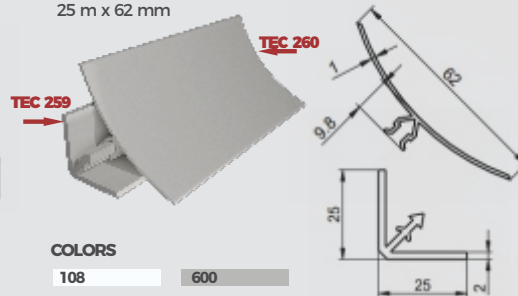

#### COLORS

108 600

## Overlapping Inner Corner

### TEC 309

76,2 mm x 48,1 mm



#### COLORS

184 374 651



## **PERFIS DE REFRIGERAÇÃO**

### **REFRIGERATION PROFILES**

Tecnofil also offers a wide variety of profiles for commercial refrigeration. These components are made of high-quality PVC and are designed to ensure proper thermal insulation, wear resistance, and easy installation.

They are essential for the proper functioning and energy efficiency preservation of refrigeration equipment.

# REFRIGERATION

## Molding Profile 43 mm

**TEC 020**

15 mm x 43 mm

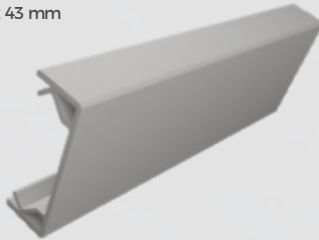

COLORS



## Molding Profile 35 mm

**TEC 252**

13 mm x 35 mm

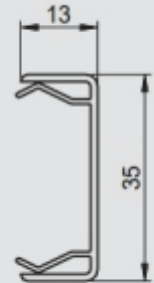
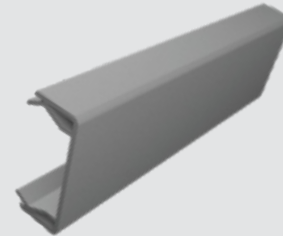

COLORS

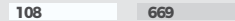

## Molding Profile 58 mm

**TEC 021**

15 mm x 55 mm

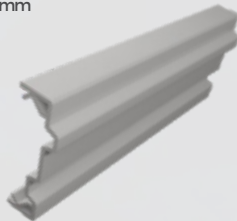

COLORS



## Night Cover Profile

**TEC 080**

31,5 mm x 18 mm

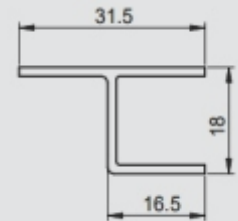
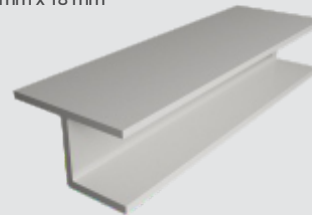

COLORS





# REFRIGERATION

## Sheet Splice Profile

**TEC 171**

1.2 mm x 30 mm

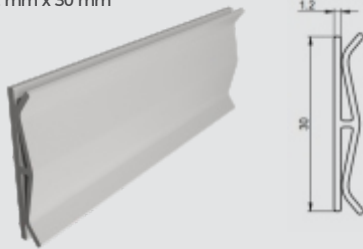

**COLORS**

108 619

## Sliding Glass Profile

**TEC 248**

18 mm x 16 mm

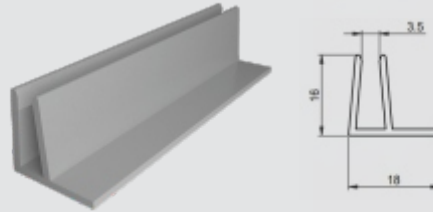

**COLORS**

108 663

## Thermal Bridge Profile

**TEC 376**

14 mm x 27 mm

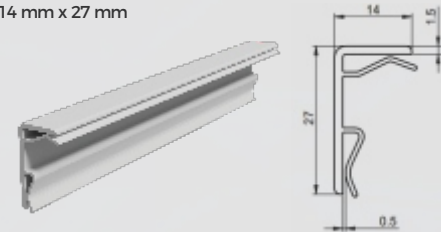

**COLORS**

163 651

## Double Lower Sliding Profile

**TEC 255**

11 mm x 24 mm

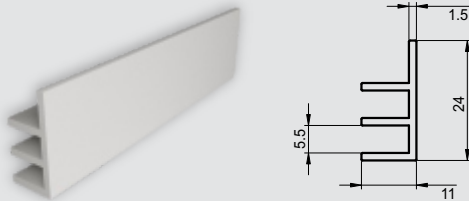

**COLORS**

663

## Double Lower Sliding Profile

**TEC 256**

18 mm x 24 mm

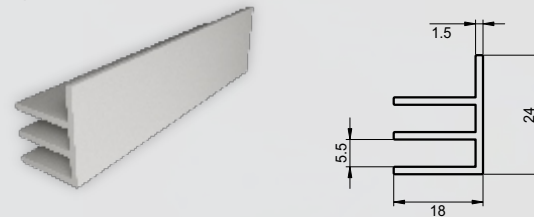

**COLORS**

663

# REFRIGERATION

## Package Holder Molding Profile

### TEC 340

By Order.

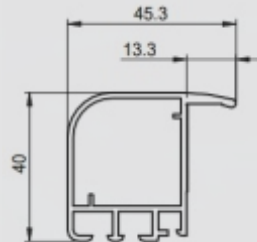
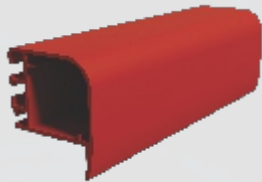

#### COLORS

Por encomenda

## Click Profile

### TEC 341

By Order.

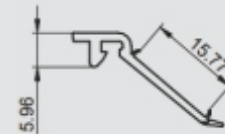
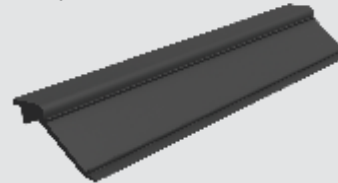

#### COLORS

952

## HANDLE

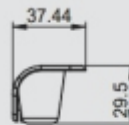
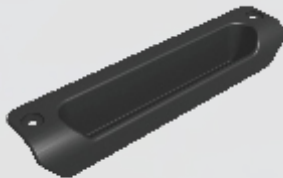

#### COLORS

900

# REFRIGERATION

## Base Profile

### TEC 126

16,7 mm x 55,6 mm

## Bumper Profile

### TEC 127

20 mm x 60 mm

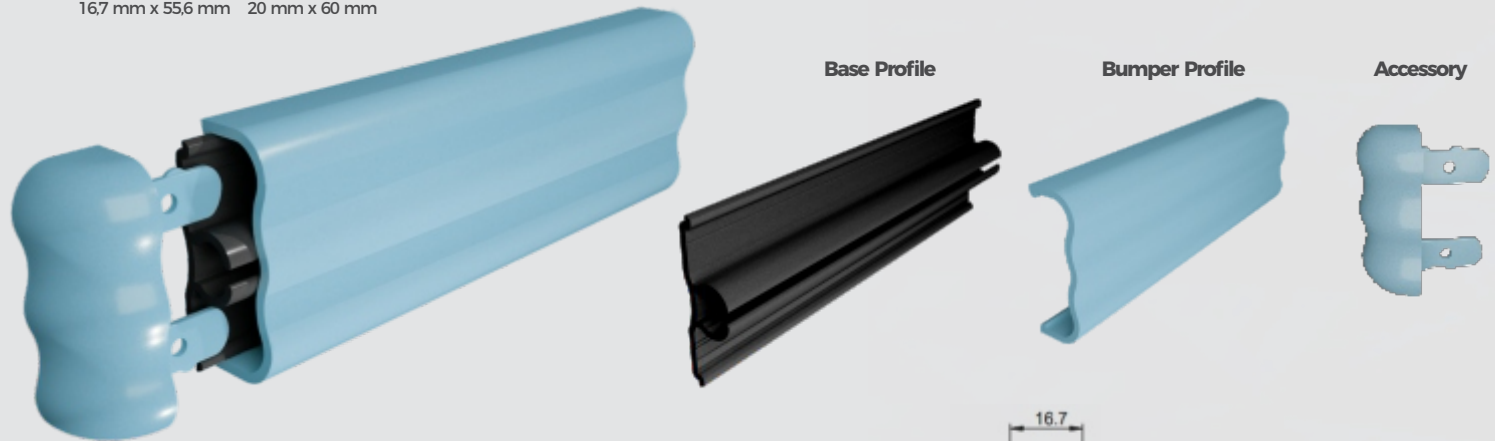

Base Profile

Bumper Profile

Accessory

## COLORS

### Bumper Profile - TEC 127

103	778	467	409
411	303	637	288
804	506		

### Base Profile - TEC 126

928

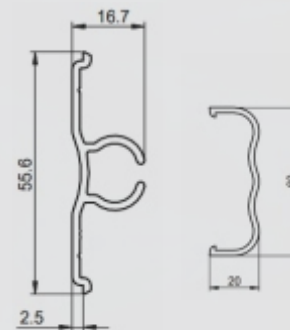

# REFRIGERATION

## Bumper Profile

### TEC 054

Length 4 meters

## Base Bumper Profile 50 mm

### TEC 055

Length 4 meters

Perfil Base

Bumper Profile

Accessory

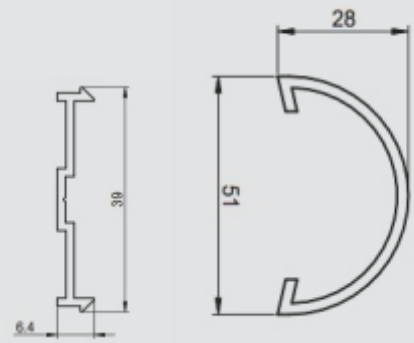
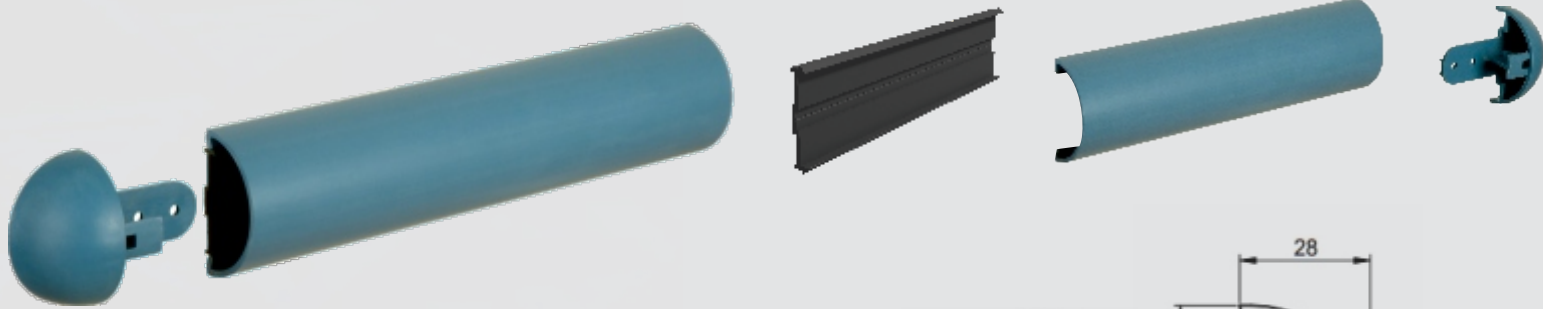

#### COLORS BUMPER

103	778	303	411
467	409	637	288

#### COLOR BASE PROFILE

928
-----





# PORTA ETIQUETAS

## **LABEL HOLDERS, PRICE TAG HOLDERS, PEG BOARD/HANG-TAG ATTACHMENTS**

Used in supermarkets, pharmacies, hardware stores, self-service stores, and in general commerce, label holders or label holders decorate shelves and racks, and are used to provide information about prices, details, and codes of the displayed products.

Durable, decorative, and functional, label holder profiles are produced by Tecnoperfil in various colors and sizes to adapt to the various models of shelves available in the market.

## Label Holders, Price Tag Holders, Peg Board/Hang-Tag Attachments

### TEC 499

UNIVERSAL LABEL HOLDER  
MODEL L WITH DOUBLE-SIDED  
ADHESIVE TAPE  
38 mm

APPLICATIONS  
Gondolas and shelves  
made of steel, glass, or  
wood.

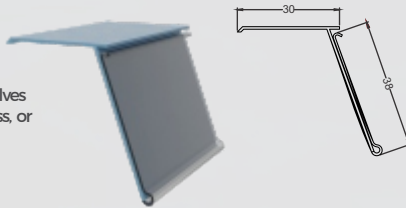

### TEC 030

LABEL HOLDER WITH CRYSTAL  
DISPLAY AND DOUBLE SIDED TAPE  
35mm

APPLICATIONS  
Refrigerated  
islands and flat  
banners.

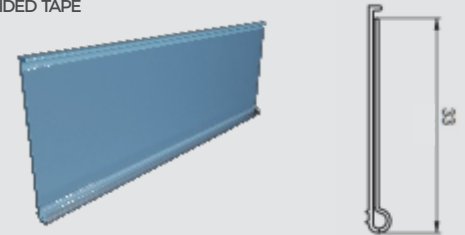

### TEC 285

LABEL HOLDER WITH CRYSTAL  
DISPLAY AND DOUBLE SIDED TAPE  
42mm

APPLICATIONS  
Refrigerated islands and  
flat banners.

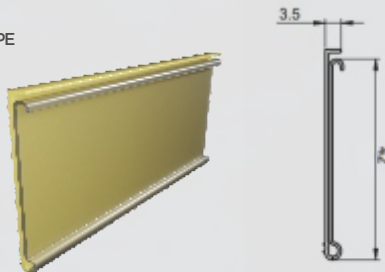

### SUPER TEC 480

LABEL HOLDER WITH CRYSTAL  
DISPLAY AND DOUBLE SIDED TAPE  
80 mm

APPLICATIONS  
Wholesale and Retail  
in general.

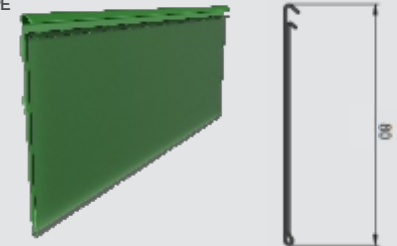

#### COLORS

204	206	226	424	404	432	900
000	108	604	804	506	304	310

## Label Holders, Price Tag Holders, Peg Board/Hang-Tag Attachments

### TEC 287

LABEL HOLDERS FOR HANG  
TAG ATTACHMENTS  
48mm

APPLICATIONS  
Hooks with 6mm wires.  
Available in sizes 55 mm,  
75 mm, 90 mm  
and 110mm.

Available Color: Crystal

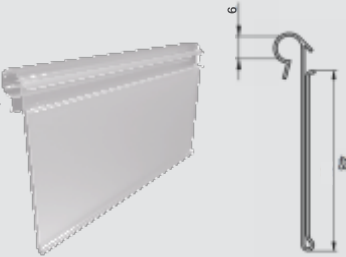

### TEC 263

LABEL HOLDERS FOR HANG  
TAG ATTACHMENTS  
36,4mm

APPLICATIONS  
Hooks with 4mm wires.  
Available in sizes 55 mm,  
75 mm, 90 mm  
and 110mm.

Available Color: Crystal

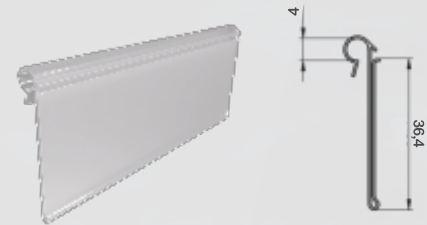

### TEC 497

LABEL HOLDER WITH LOCK  
35 mm

APPLICATIONS  
Hooks with 6mm wires.  
Available in sizes  
75 mm, 90 mm  
and 110mm.

Available Color: Crystal

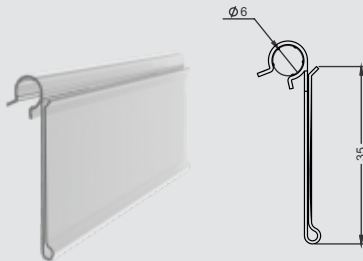

### TEC 498

LABEL HOLDER WITH LOCK  
80 mm

APPLICATIONS  
Hooks with 6mm wires.  
Available in sizes  
90 mm and 110mm.

Available Color: Crystal

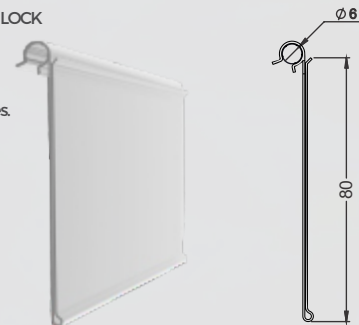

## Label Holders, Price Tag Holders, Peg Board/Hang-Tag Attachments

### TEC 257

LABEL HOLDER WITH  
CRYSTAL DISPLAY IN PVC  
39 mm

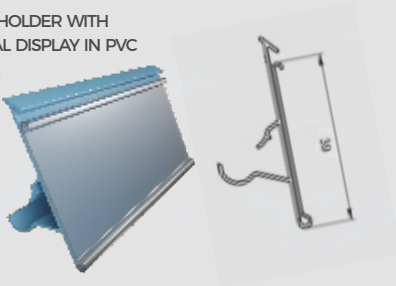

### TEC 139

LABEL HOLDER WITH  
CRYSTAL DISPLAY IN PVC  
32 mm

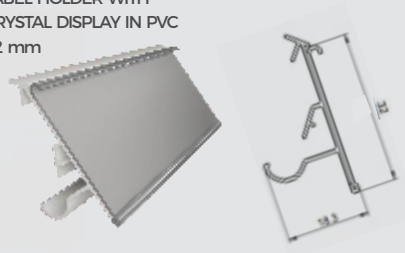

### TEC 265

LABEL HOLDER WITH  
CRYSTAL DISPLAY IN PVC  
29 mm

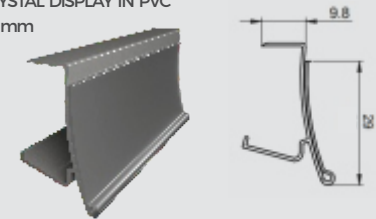

### TEC 152

LABEL HOLDER WITH  
ADJUSTMENT FOR  
BULKHEADS AND  
CRYSTAL DISPLAY  
39 mm

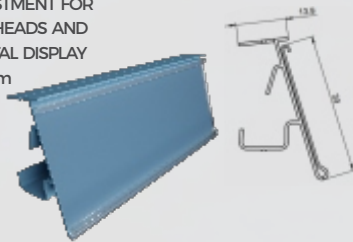

### TEC 025

LABEL HOLDER WITH  
CRYSTAL DISPLAY IN PVC  
38 mm

APPLICATIONS  
Refrigerated  
counters; and  
older Eletrofrío  
gondola shelf  
models

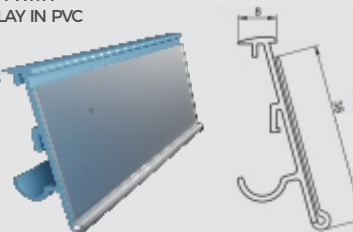

### TEC 266

LABEL HOLDER WITH  
CRYSTAL DISPLAY IN PVC  
39 mm

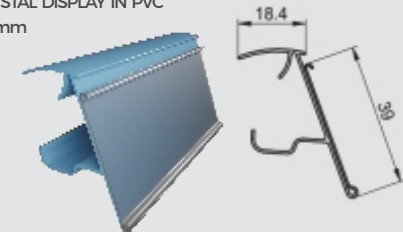

#### COLORS

204	206	226	424	404	432	900
000	108	604	804	506	304	310



## Label Holders, Price Tag Holders, Peg Board/Hang-Tag Attachments

### TEC 322

LABEL HOLDER  
WITH ADJUSTMENT  
FOR BULKHEADS  
AND CRYSTAL  
DISPLAY  
38 mm

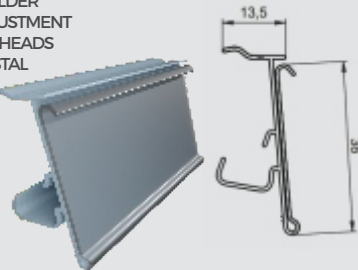

### TEC 325

PLABEL HOLDER  
WITH ADJUSTMENT  
FOR BULKHEADS  
AND CRYSTAL  
DISPLAY  
40 mm

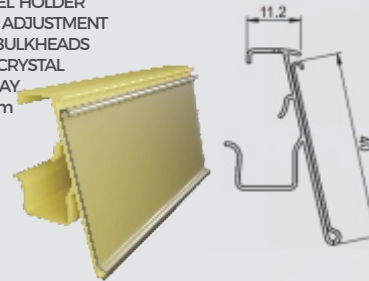

### TEC 500

FRONTAL PROTECTOR  
FOR GONDOLAS  
60 mm

APPLICATIONS  
Between the  
adjustment of the  
label holder and the  
gondola

Available Color:  
Crystal

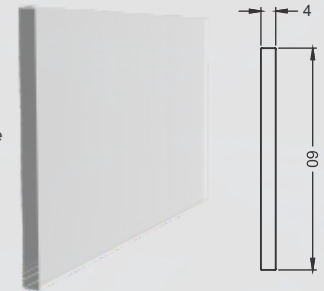

## Tilting Label

### TEC 247

TILTING LABEL  
HOLDER WITH  
CRYSTAL DISPLAY  
40.3 mm

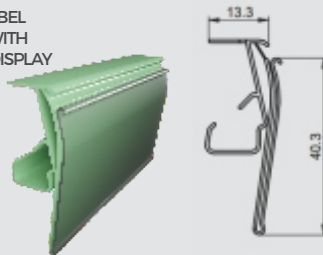

### TEC 146

TILTING LABEL  
HOLDER WITH  
CRYSTAL DISPLAY  
37.5 mm

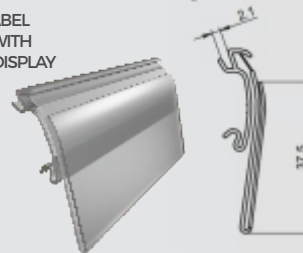

### TEC 231

TILTING LABEL  
HOLDER WITH  
CRYSTAL  
DISPLAY  
40 mm

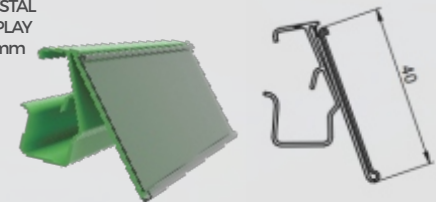

#### COLORS

204	206	226	424	404	432	900
000	108	604	804	506	304	310

## **ELECTRONIC LABEL TRACKS**

Tecnofil's rails for electronic tags are the perfect solution to add a modern and practical touch to your retail spaces.

Made of high-quality PVC, these rails are specially designed for the electronic tags of the SEAL and TOLEDO DO BRASIL brands, ensuring that your prices are always clearly and attractively displayed.

Versatile and easy to install, these rails can be applied to shelves, counters, and more.

Transform your store simply and effectively with Tecnofil electronic tag rails.

## Electronic Label Tracks

### TEC 346

STRAIGHT BASE CLIP  
PROFILE FOR ELECTRONIC  
LABEL TRACKS  
18 mm

System with exclusive tilt adjustment, giving  
a better view in various positions.



#### COLORS

 000

 108

 604

 900

### TEC 347

PVC ELECTRONIC  
LABEL TRACKS  
31,5mm

System with exclusive  
tilt adjustment, giving  
a better view in various positions.

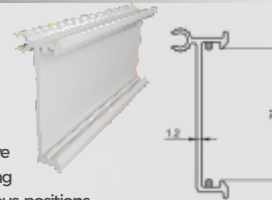

### TEC 347 T

TRACK TERMINAL FOR  
ELECTRONIC LABELS  
39 mm

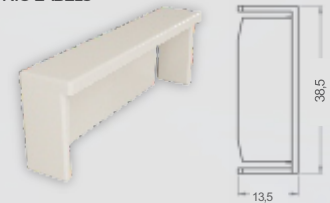

### TEC 401

PVC HANG-TAG ATTACHMENTS  
FOR ELECTRONIC LABELS

APPLICATIONS  
Hooks with 4 to 10 mm  
wires.

Co-extrusion system in  
Flexible PVC. Available  
in sizes 55mm e70mm.

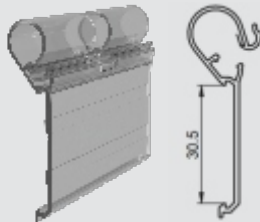

#### COLORS

 000

### TEC 438

By Order.

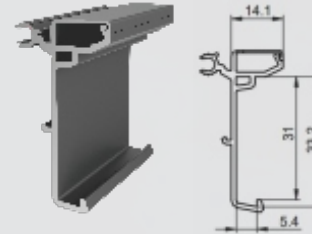

#### COLORS

 000

 900

 108

 604

## Rail Profile

### TEC 458

By Order.

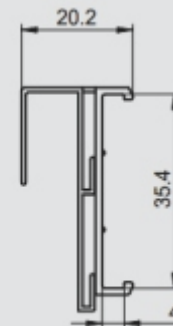
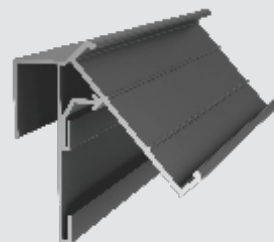
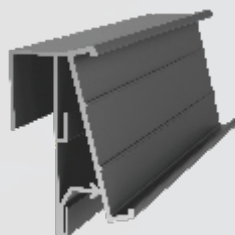

COLORS

900

108

604

## Positioning Profile

### TEC 459

By Order.

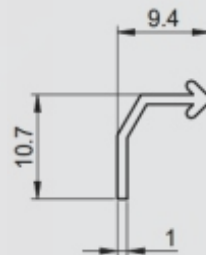
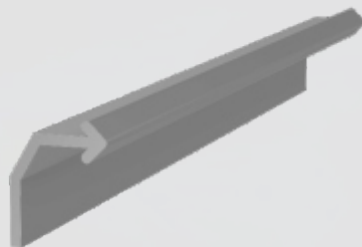

COLORS

604



 **PERFIS  
CHECK OUT****SELF-SERVICE PROFILES**

The self-service profile system from Tecnofil is a solution designed to provide a variety of protection options for cash registers, self-service counters, and refrigerated displays.

Made with rigid PVC and polypropylene accessories, these profiles guarantee an excellent finish and harmonious integration into the equipment they are applied to. Their installation is simple, they offer a range of colors to choose from, are easy to maintain, and resist humidity.

Additionally, they do not propagate flames and are easy to clean. The assembly of the profiles provides impact resistance, ensuring the durability of the final product.

# SELF-SERVICE PROFILE SYSTEM

**Checkout Profile**  
**Bumper Profile**  
**TEC 178**

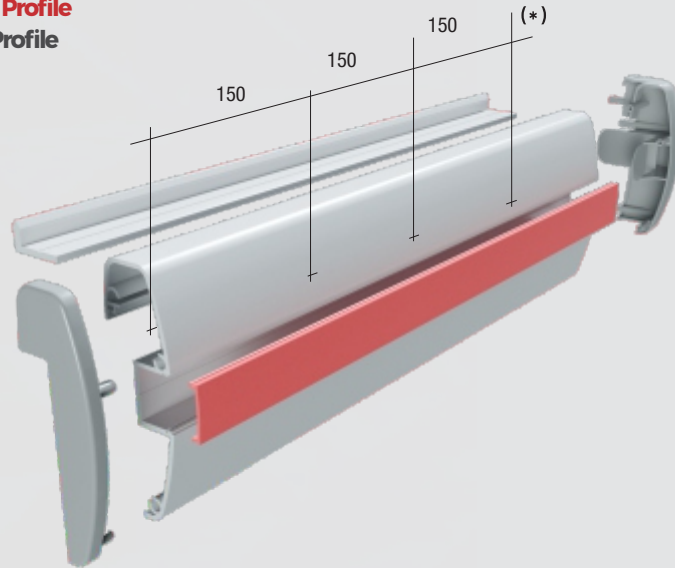

(\*) Recommended distances for holes and product fixation.  
 Available in the size of 6 m.

## Accessories



Right  
end cap



Left  
end cap



External Curve  
90°



Internal Curve  
90°

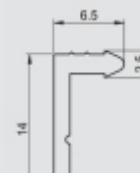

Fixing Profile  
TEC 180



Bumper Profile  
TEC 178

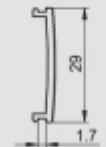

Channel Cover Profile  
TEC 179

## COLORS

**Channel Cover Profile - TEC 179**



**Bumper Profile**



**Fixing Profile**

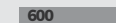

**Accessories available in color**



# SELF-SERVICE PROFILE SYSTEM

Profile for Balconies and Islands

**Bumper Profile**  
**TEC 267**

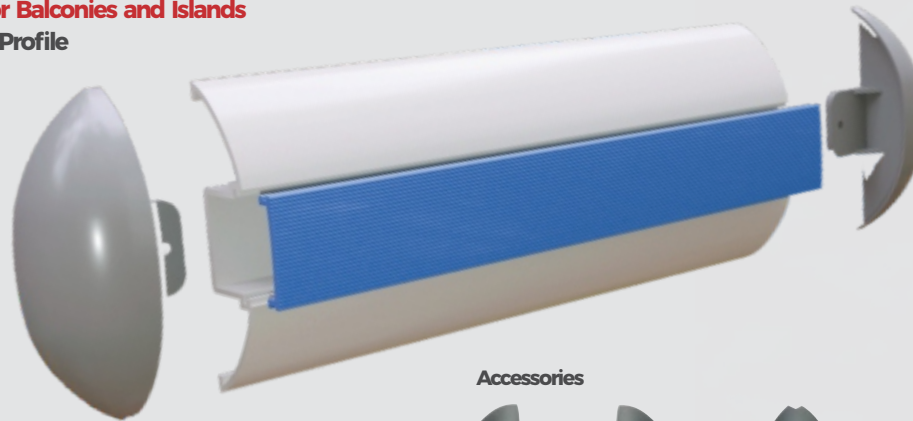

Available in lengths of 6 m

### Accessories

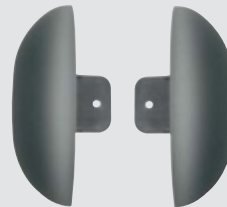

Right/left end cap



Elbow  
90°

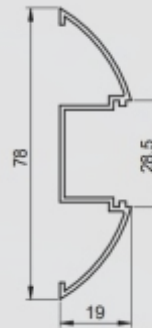

**BUMPER Profile**  
**TEC 267**

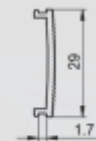

**Channel Cover Profile**  
**TEC 179**

### COLORS

**Channel Cover Profile - TEC 179**



**Bumper Profile**



**Accessories available in color**





# SINALIZAÇÃO

## SIGNAGE

### **Signage and protection of columns and walls.**

Discover versatile solutions for effective protection and signage in various environments. Ideal for installation in commercial garages, supermarkets, shopping centers, schools, hotels, and more.

Our products undergo rigorous quality and impact resistance tests, guaranteeing maximum protection.

In addition to safety, they facilitate garage and parking lot signage. They are resistant, hygienic, easy to clean, low-cost, and do not require painting, avoiding additional maintenance costs.

Ensure the safety and practicality necessary for your establishment now!

# FLEXIBLE

## Anti-slip Flexible Profile

**TEC 900**

60 mm x 24 mm

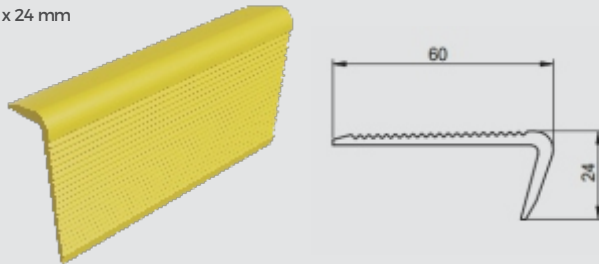

COLORS

711 623 905 301

## Flexible Corner Guard

**TEC 911**

40 mm x 40 mm x 2 mm

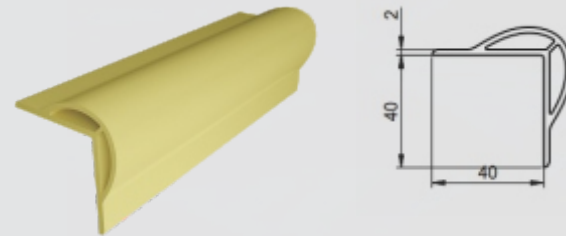

COLORS

711 107 905 301

## Flexible Corner Guard

**TEC 912**

60 mm x 60 mm x 2.5mm



COLORS

711 107 905 301

## Flexible Profile

**TEC 913**

150mm x 2,8mm

Roll with 15m

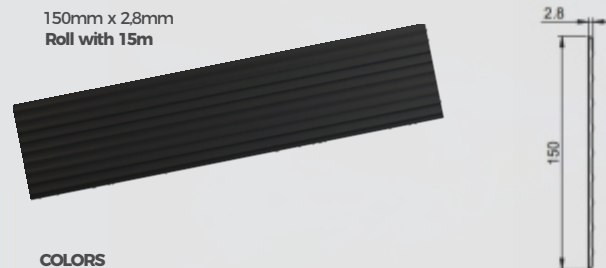

COLORS

635 905

Disponibile con cinta adesiva di doble cara

# FLEXIBLE

## Triangular Flexible Profile

**TEC 906**

16.7 mm x 49.3 mm

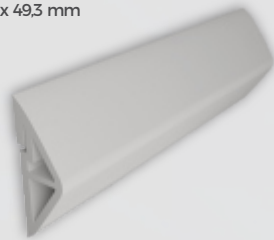

COLOR

619

## Podium Finish Flexible Profile

**TEC 901**

22 mm x 45 mm

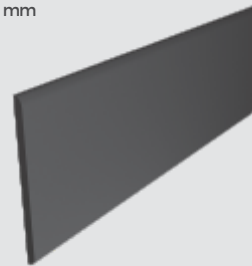

COLOR

605

900

## Bumper Flexible Profile

**TEC 903**

9 mm x 90 mm

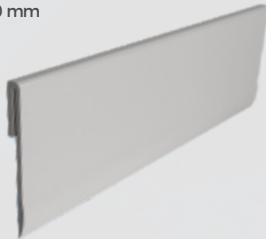

COLOR

605

## Flexible Bumper Profile

**TEC 904**

50 mm x 50 mm

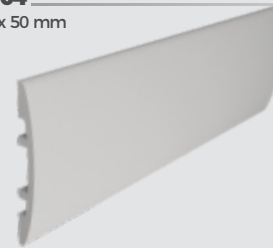

COLOR

605

# VARIOUS

## Bound Profile

**TEC 039** **TEC 040** **TEC 041**

4 mm      7 mm      10 mm

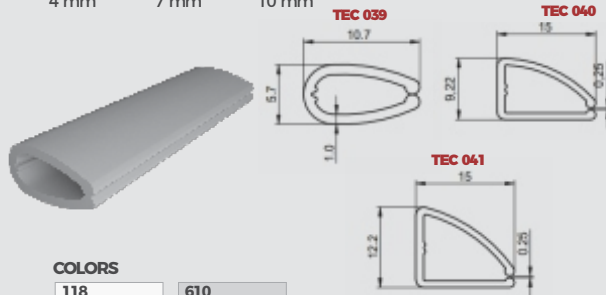

### COLORS



## Top Finish Profile

**TEC 046 B**

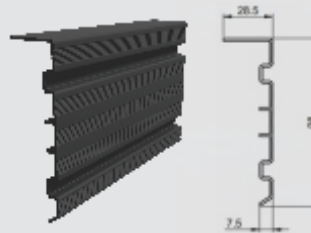

### COLOR

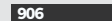

## L Profile 40x10x1

**TEC 474**

By Order

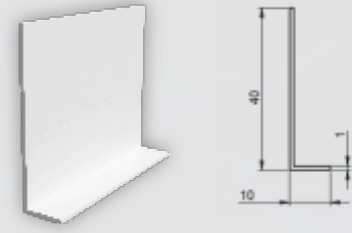

### COLOR

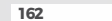

## Flat Profile 30x5

**TEC 472**

By Order



### COLOR

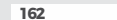

## L Profile 20x10x1

**TEC 473**

By Order

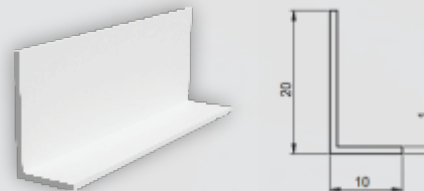

### COLOR





## VARIOUS

### U Profile 35x25x1,5

**TEC 507**

By Order

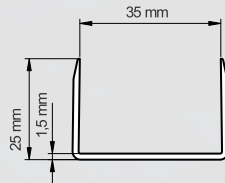
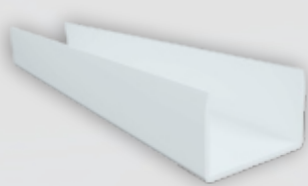

COLOR

162

### PVC Profile 15x15x1

**TEC 475**

By Order

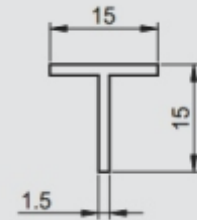

COLOR

162

### U Profile 10x18x1

**TEC 476**

By Order

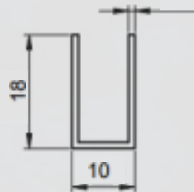

COLOR

162

### Flat Profile 17x3

**TEC 477**

By Order



COLOR

162

# BUS

## Roof Center Finish Profile

### TEC 243

6,1 mm x 32,5 mm

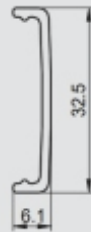

#### COLORS

Consult

## GranVia Bench Profile

### TEC 244

12,8 mm x 49,5 mm

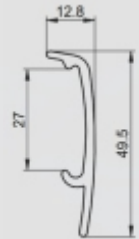

#### COLORS

Consult

## Urban Side Longitudinal Profile

### TEC 245

21,4 mm x 48,6 mm

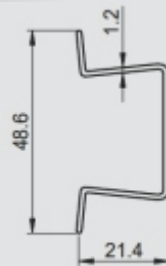
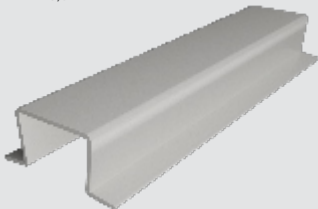

#### COLORS

Consult

## DENTAL MOLDING PLATES IN EVA!

Dental molding plates made of EVA are recommended for **creating splints, molds, or orthodontic braces for the teeth.**

They are useful in **dental whitening procedures, bruxism control, and as mouthguards or splints for dental treatments.**

They are produced in **round and square versions, in three thicknesses:**

**1mm, 2mm e 3mm.**

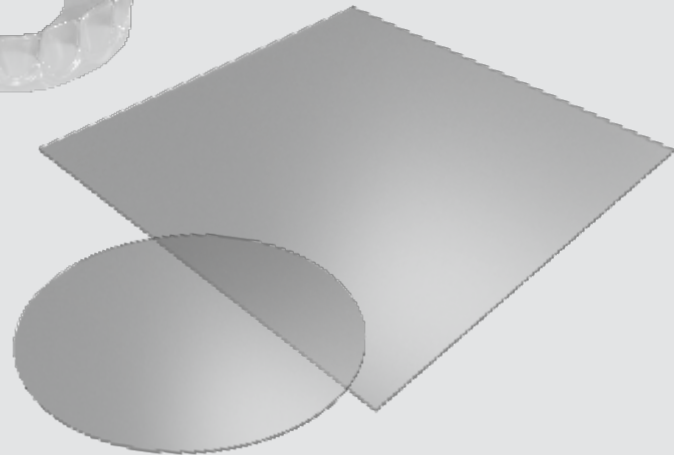

### MAIN DIMENSIONS

Round	Square
Ø 133mmx 1mm	135mmx 135mmx1mm
Ø 133mmx 2mm	135mmx135mmx2mm
Ø 133mmx 3mm	135mmx 135mmx3mm

## SPECIAL PROJECTS

Turn your ideas into reality with TecnoPerfil. With three decades of excellence in plastic profiles, we offer not only a wide range of products, but also customized solutions that meet your specific needs.

By choosing TecnoPerfil, you bring quality, trust, and commitment to your project, recognized worldwide.

### Why Choose TecnoPerfil?

- ✓ Confidence in the confidentiality of projects;
- ✓ On-time delivery;
- ✓ Standardized production for efficient continuity;
- ✓ Logistics focused on meeting deadlines and preserving products;
- ✓ Compliance with regulatory requirements.

Trust in our experience and expertise and turn your ideas into reality with TecnoPerfil.

    @tecoperfil

[tecoperfil.com.br](http://tecoperfil.com.br)



**TECOPERFIL<sup>®</sup>**

Street Rui Barbosa, 210 | District Costa e Silva  
Industrial District | 89219-520 | Joinville | SC



**+55 47 3431.1200**